



New perspectives with KNX
KNX IoT
KNX Secure
ETS Inside

Light + Building 2016
Frankfurt am Main, Germany

www.knx.org

New perspectives with KNX

In the next 10 minutes...



Then, Now, Tomorrow*

On a time travel with KNX into the **Future**
Outlook on the newest KNX **System & Tools** development

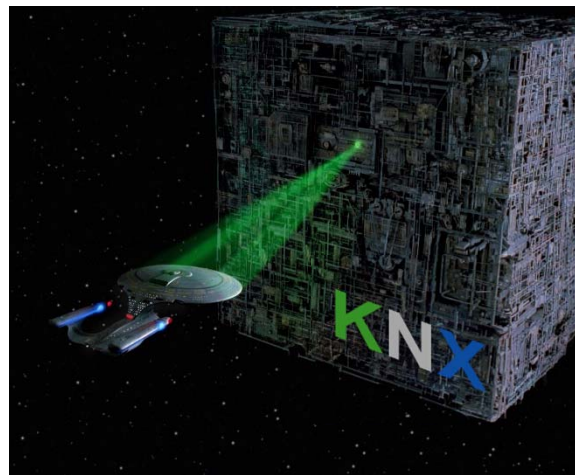

** Star Trek 'Next Generation'; final episode*

New perspectives with KNX

Past Light + Building fairs



2010

KNX presents the new ETS4!

- Easy!** User interface
- Fast!** Im-/export
- Open!** Open XML format



2010

2012

KNX presents the new ETS App concept!

- Functional!** Solution oriented
- Flexible!** Unlimited possibilities
- Individual!** Only on demand

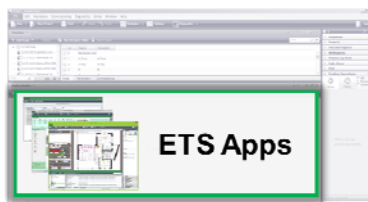

2012

2014

KNX presents the new ETS5!

- Embedded!** Everything integrated
- Smart!** Clear and tidy
- Wireless!** RF as easy as TP



2014

New perspectives with KNX

Current Light + Building 2016



The KNX Association presents the topics that will shape the next decade.

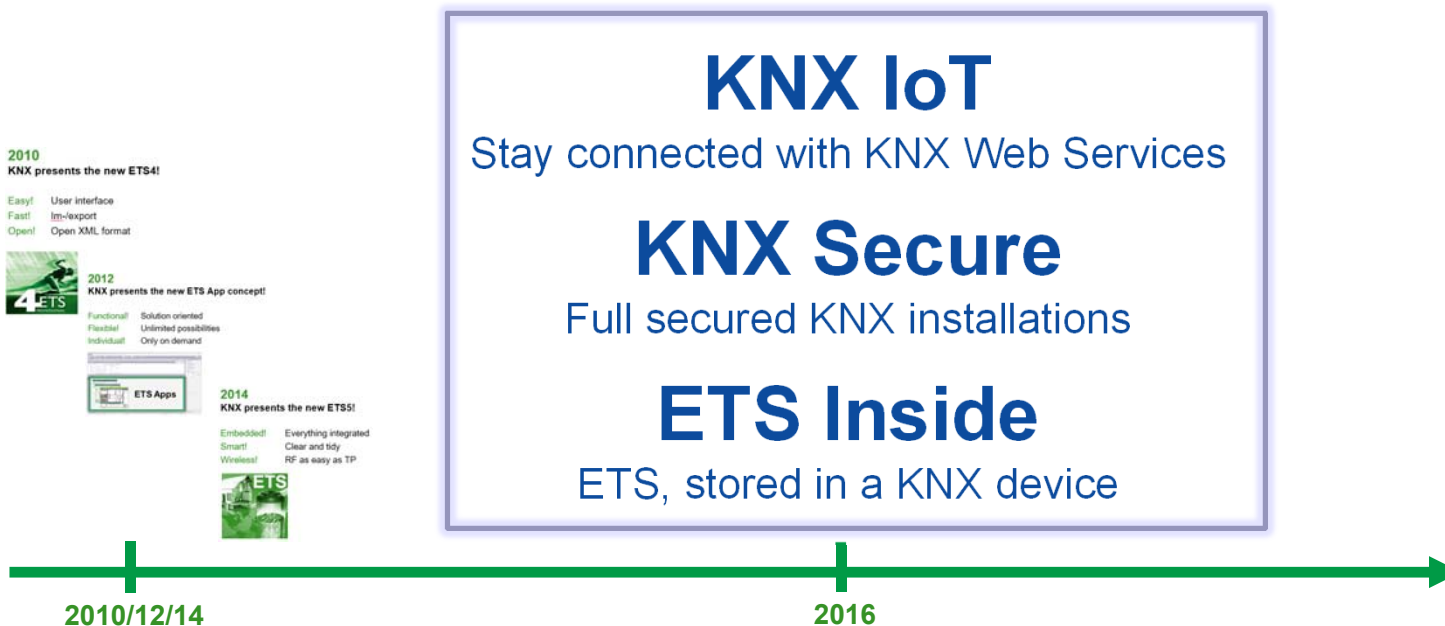

New perspectives with KNX



1. KNX IoT

New perspectives with KNX

KNX IoT → Question



**How to connect my KNX installation to
all the things in the internet?**



New perspectives with KNX

KNX IoT → Answer



With KNX Web Services!

KNX Web Services are ... “Internet” ready

- Integrate a KNX based system easily and in a standardized way in an(y) IT infrastructure

New perspectives with KNX

KNX IoT



Internet of Things



Definition (Wikipedia)

- Network of physical **objects** or “things” embedded with electronics, software, sensors and **network connectivity**
- Objects able to **collect and exchange data**
- Enabling **connection** between **physical** world and **computer** based systems
- Each “thing” uniquely **identifiable**
- Each “thing” is able to **interoperate** with internet infrastructure
- 2020: 50 billion such objects

New perspectives with KNX

KNX IoT



KNX, already long part of the IoT?

Since more than 10 years, KNXnet/IP allows to integrate KNX into IP based networks. Already since then, there is a [KNX of Things](#) (KNXoT) – compare previous definition Wikipedia.

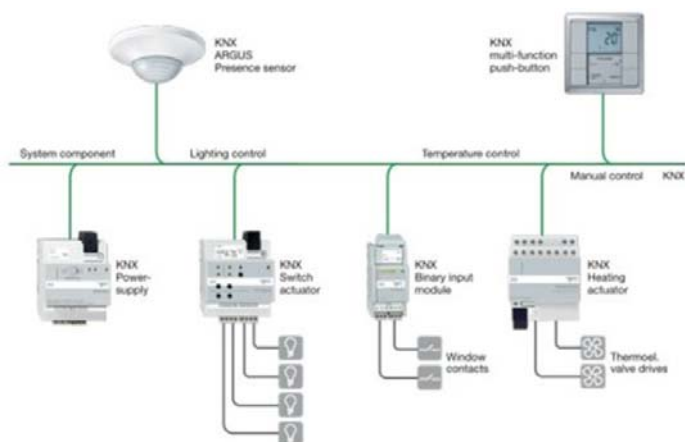

- Physical **objects** → KNX devices
- Network **connectivity** → TP, RF, PL, IP
- **Collect and exchange data** → group objects/interface objects – properties
- Connection between **devices** and **computers** → KNX data interfaces
- Each “thing” uniquely **identifiable** → KNX serial number and/or individual address
- Each “thing” able to **interoperate** with internet infrastructure → KNX IP Routers

New perspectives with KNX

KNX IoT



Current trend: APIs

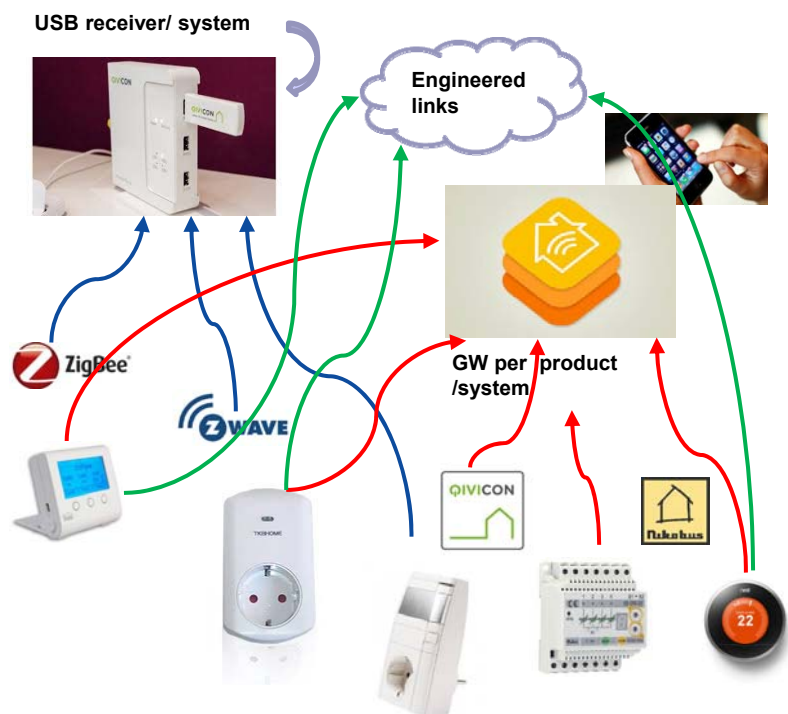

Reunite different *home automation* solutions via a unified interface

- In a central device in the installation
- In your Smart Phone
- In the Cloud

Drawbacks of these solutions compared to KNX

- Increased **complexity** of the installation (*look to the left*)
- No proven reliability of these solutions (yet)
- Central device is weak spot in these concepts

But: Data is power! Information on the user profiles of the smart device could provide business opportunities

Offering of additional services → data mining

But: there is no strict need to be able to access every single data element in a home/building (e.g. occupancy mode)

New perspectives with KNX

KNX IoT



KNX Web Services, the goal ...

Create a possibility that IT systems and KNX networks can be interlinked by means of a KNX Gateway!

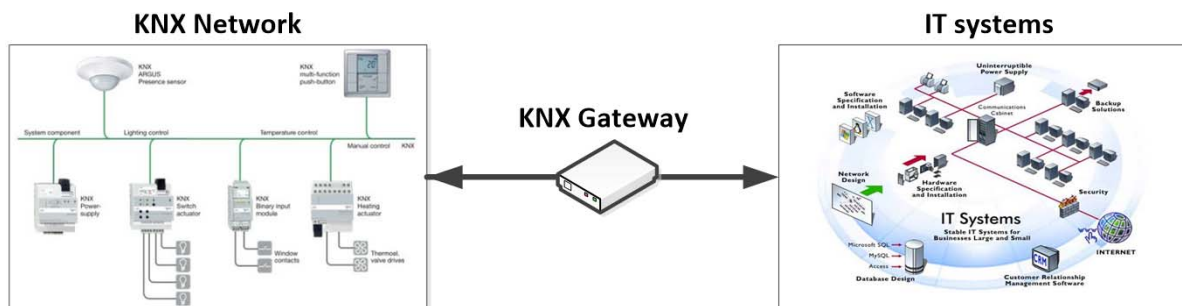

New perspectives with KNX

KNX IoT



KNX Web Services, how we did it...

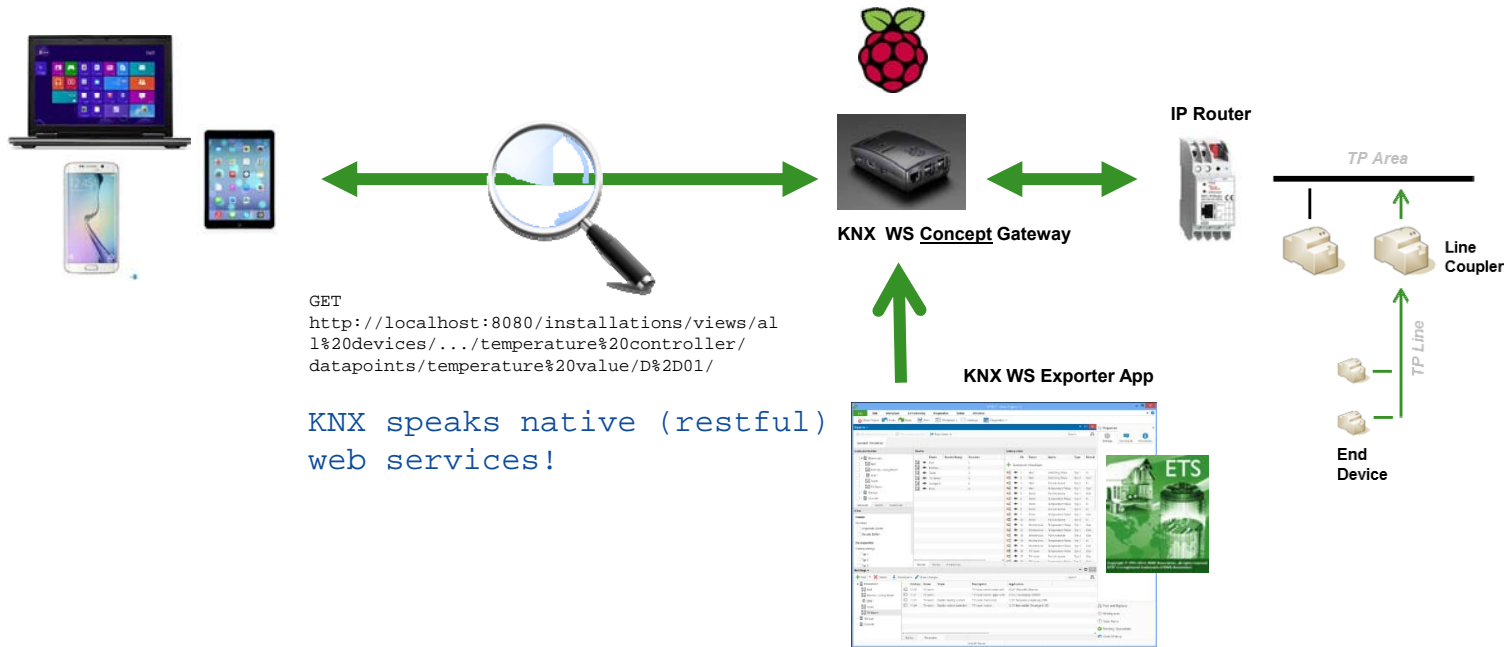

New perspectives with KNX

KNX IoT



KNX Web Services, what we deliver...

KNX will offer ETS WS Exporter APP and free KNX Specification.

- Export ETS project data represented according a standardized (tagged) KNX information model
- Possibility to add additional data (e.g. geo- localization info of project devices) before exporting

KNX will offer sample implementation of WS Gateway.

- Usable on Raspberry PI 2 Linux platform
- Including WS Gateway binary software to map tagged project data to oBIX (open Building Information Exchange) object model
- With example of WS client allowing browsing through connected installation (reading/writing values)

New perspectives with KNX



2. KNX Secure

New perspectives with KNX

KNX Secure



KNX Security Today

When taking the proper measures, the safety level of KNX installations can already be made increased today → see standardized KNX security checklist

Examples of such measures in the KNX security checklist

- Preventing access to the network via the various KNX physical media
 - *avoid IP addresses directly accessible from the internet*
- Limiting unwanted communication inside the network
 - *Load Filter Tables of Couplers*
- Protecting configuration communication
 - *Set a Device (BAU) Password*
- ...

Find the checklist on www.knx.org

New perspectives with KNX

KNX Secure → Question



**How to ensure (maximum) privacy/
security of a KNX installation?**



New perspectives with KNX

KNX Secure → Answer



With KNX Secure!

KNX Secure is... SAFE

- KNX Secure uses AES128 CCM for encryption/ authentication
- *Advanced Encryption Standard (AES)* is a standard encryption algorithm (ISO/IEC 18033-3)

New perspectives with KNX

KNX Secure



Technology Concept, IP Secure

KNX IP Secure encrypts the entire KNXnet/IP frame.

All KNX telegrams between two (or more) IP Couplers are **SECURED**

- Unsecured communication
- Secured communication

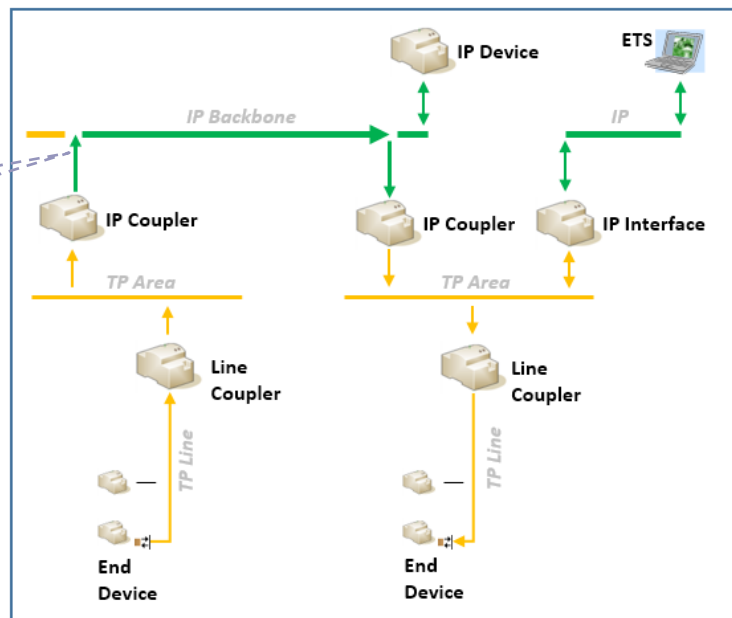

New perspectives with KNX

KNX Secure



Technology Concept, Data Secure

KNX Data Secure only encrypts the APCI and the payload.

The group communication of a particular sender (one/ more group objects) to another group object(s) is **SECURED**

- Unsecured communication
- Secured communication

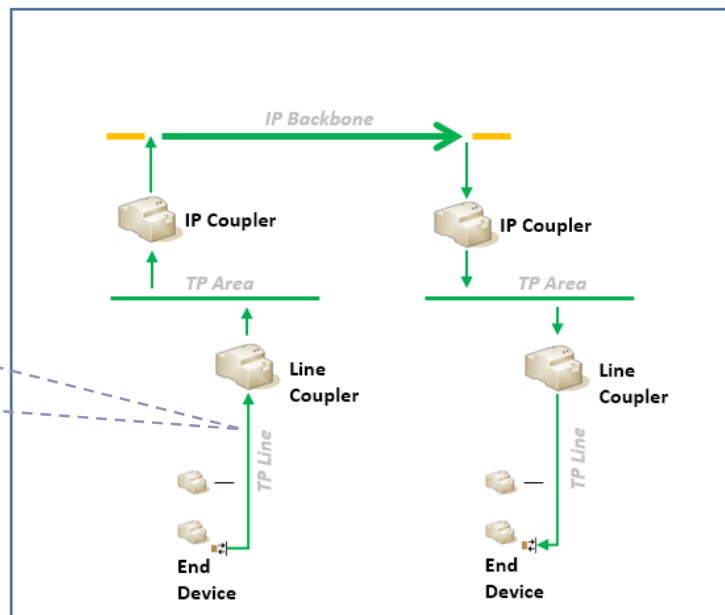

New perspectives with KNX

KNX Secure



Technology Concept

KNX IP Secure and **KNX Data Secure** can be combined in an ETS project/ installation.

ETS handles key management/ distribution, establishes 'secure links' and downloads these links in KNX Secure devices.

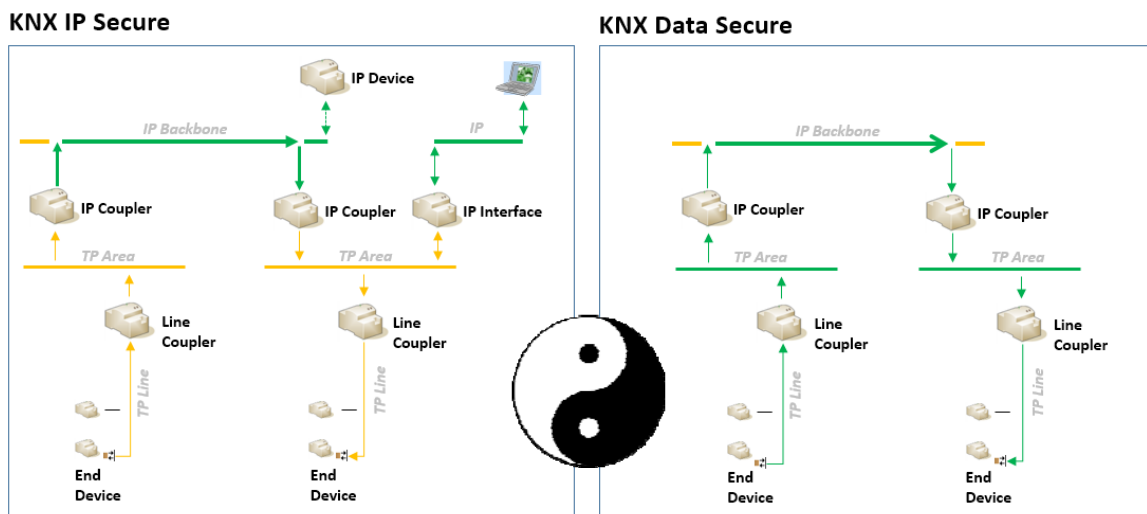

New perspectives with KNX

KNX Secure



ETS

KNX Secure affects also the ETS.

Devices

Properties

Settings IP Comments Informat...

Obtain an IP address automatic...
 Use the following IP address

IP Address
255.255.255.255

Subnet Mask
255.255.255.255

Default Gateway
255.255.255.255

MAC Address
Unknown

Routing Multicast Address
224.0.23.12

Management Password
1S+Xi+ph

Device Authentication Code
A867DA886A8E96E0290399646DE6E93

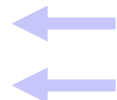

Topology (Backbone)

Properties

Settings Comments Information

Backbone Name
Backbone Bereich

Description

Status
Unknown

Backbone Medium
IP

Network Latency
WLAN (< 1s)

Multicast Address
224.0.23.12

Security
Off



Secure Project Settings

SecurityProject

Details Security Project Log Project Files

Security Key
98 E4 FE CD 5B B6 2A 5F B7 36 47 EC 13 2A CB 6C

Device Certificates
+ Add

Serial Number	Factory Key	Device
0842:10842108	42108421084210842108421084210842	1.1.1 ise smart connect KNX Sonos
4210:84210842	10842108421084210842108421084210	1.0.1 IP-Controller
8421:08421084	21084210842108421084210842108421	1.1.3 IP-Interface AP 146
9CE7:39CE739C	E739CE739CE739CE739CE739CE739CE7	1.1.- Test Device 091A

Topology Key

Device Keys

New perspectives with KNX

KNX Secure



How it works in ETS...

... is described in [detail](#) in the new ETS 5.5 help file.



KNX Secure

New perspectives with KNX



3. ETS Inside

New perspectives with KNX

ETS Inside → Question



How to attract more people to realize “Smart Home” projects with KNX?



New perspectives with KNX

ETS Inside → Answer



With ETS Inside!



ETS Inside is... **SMART, SIMPLE, SAFE**

ETS Inside is... **your ETS, stored in a KNX device**

- Create KNX installations with ETS “*inside*” for your home/building
- Use ETS Inside on any device (your tablet/ smartphone)
- Store your ETS “*inside*” in your home/building

New perspectives with KNX

ETS Inside → Two Roads to KNX success



Creating a KNX installation – your first tool option

ETS Professional

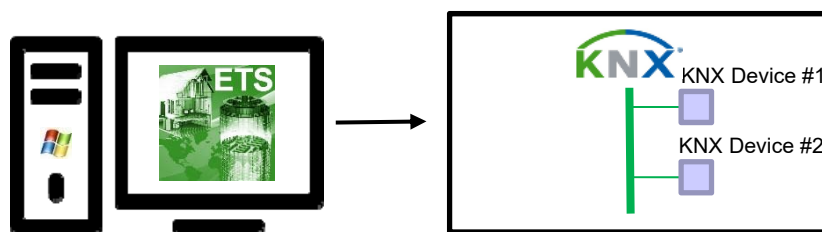
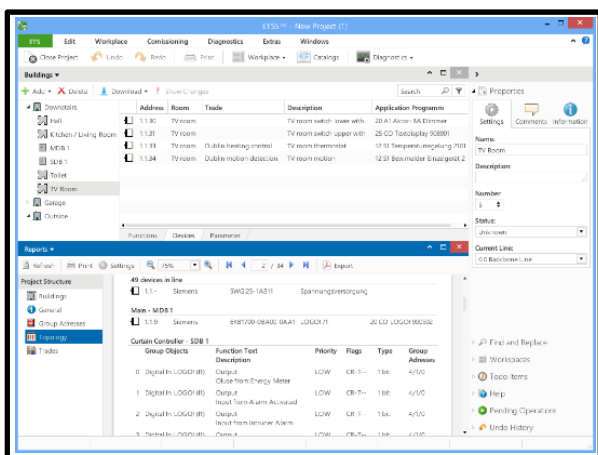

The KNX tool to create and manage KNX installations of any size or functionality level

- The tool offers the professional KNX installer lots of flexibility to arrange his work (e.g. user defined UI settings, filters, ...)
- Installer can navigate in great detail through the complete KNX project data (also offering analysis possibilities)
- A powerful PC with reasonable screen size is needed.

New perspectives with KNX

ETS Inside → Two Roads to KNX success



Creating a KNX installation – your second and new tool option

ETS Inside

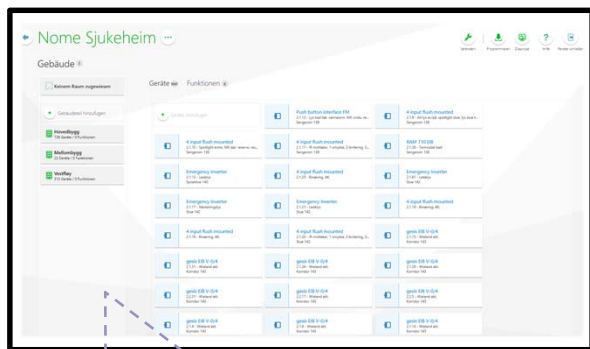

A completely new User Interface

- Abstracts KNX specificities
- Adapted to mobile devices

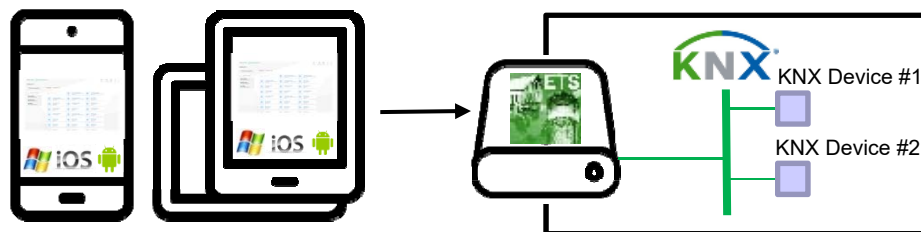

ETS Inside Device

The KNX tool to create and manage KNX installations of reduced size and functionality

- The tool supports the KNX (unskilled) installer with smart working procedures and simplified user interface.
- A handheld device with smaller screen size is sufficient.

New perspectives with KNX

ETS Inside → Architecture



Technology Overview

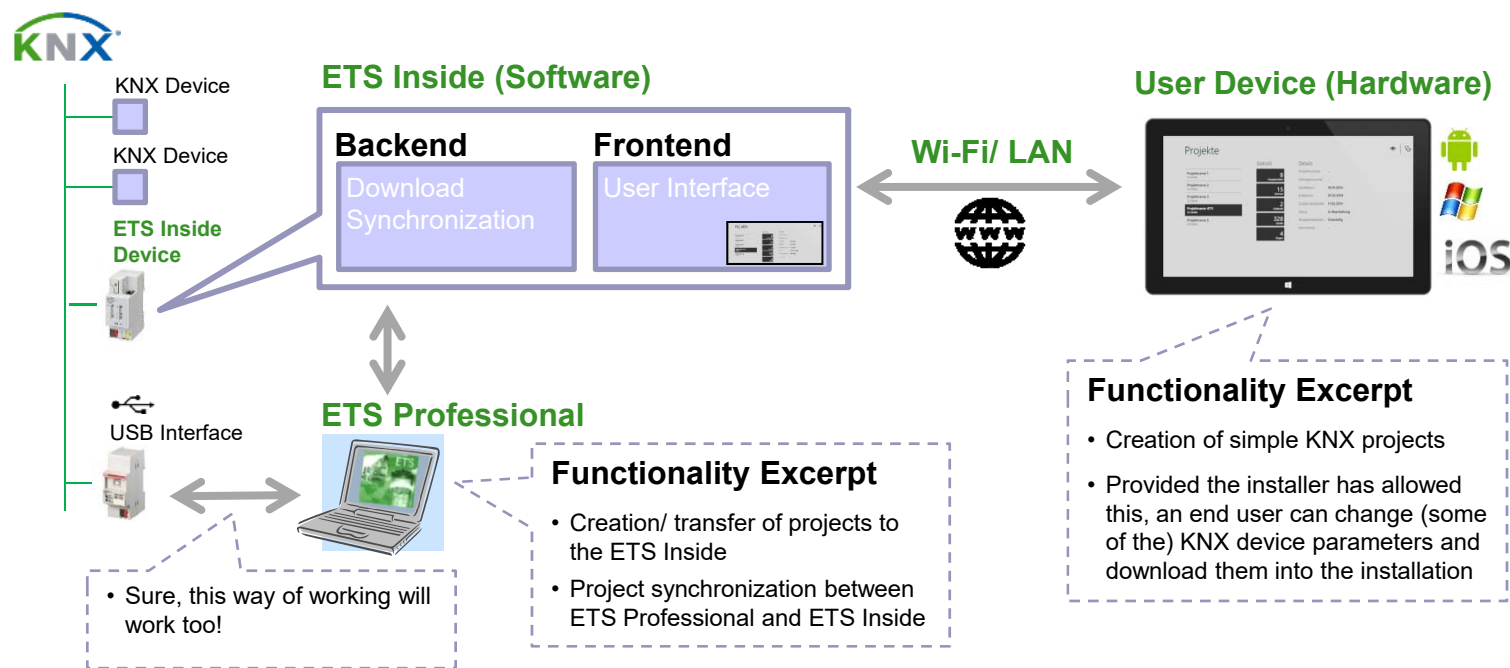

New perspectives with KNX

ETS Inside → Installer's Perspective



A new SMART way to design a KNX project!

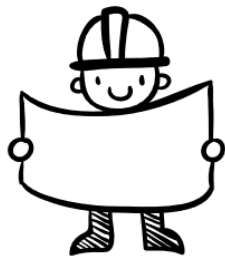

"designed by Freepic"

Benefits

- *Easier market entry*
- *Reduced start-up effort*
- *Use of standard KNX devices*
- *Exchange data with ETS Professional*

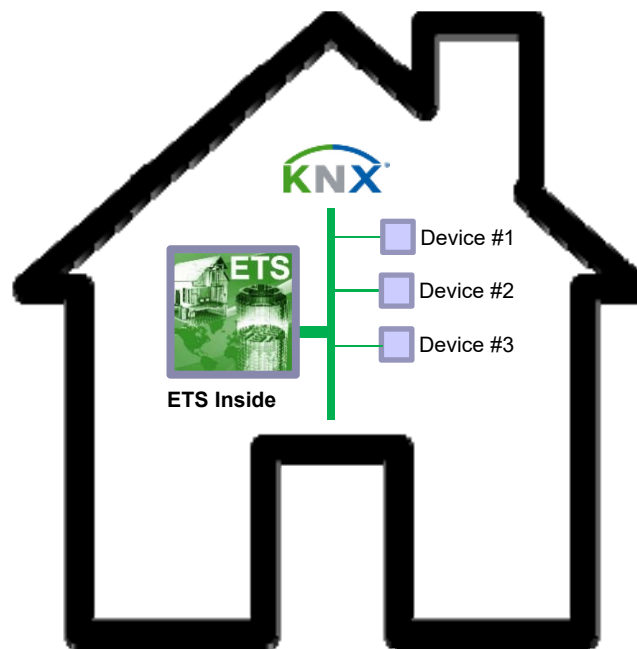

New perspectives with KNX

ETS Inside → Customer's Perspective



A SIMPLE way to manage your own KNX installation!



"designed by Freepic"

Benefits

- *Have remote access to your installation*
- *Use ETS Inside on any device, e.g. own tablet/ computer with iOS, Windows or Android*
- *Change individual parameters yourself*
- *Store your KNX project inside your home/building*

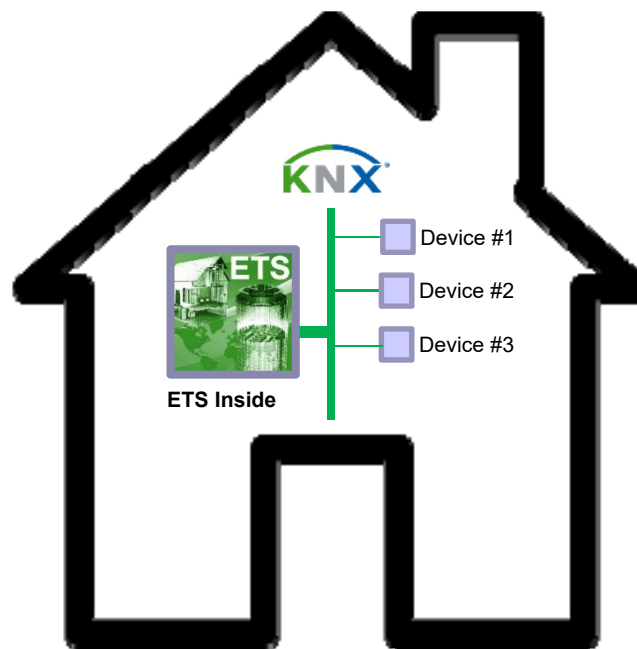

New perspectives with KNX

ETS Inside → Manufacturer Perspective



A SAFE way to address more customers!

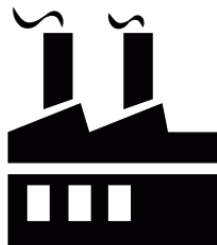

"designed by Freepic"

Benefits

- *Standard KNX devices usable (no need for gateways)*
- *Identical product training for customers as with ETS Pro*
- *KNX Secure supported also by ETS Inside*

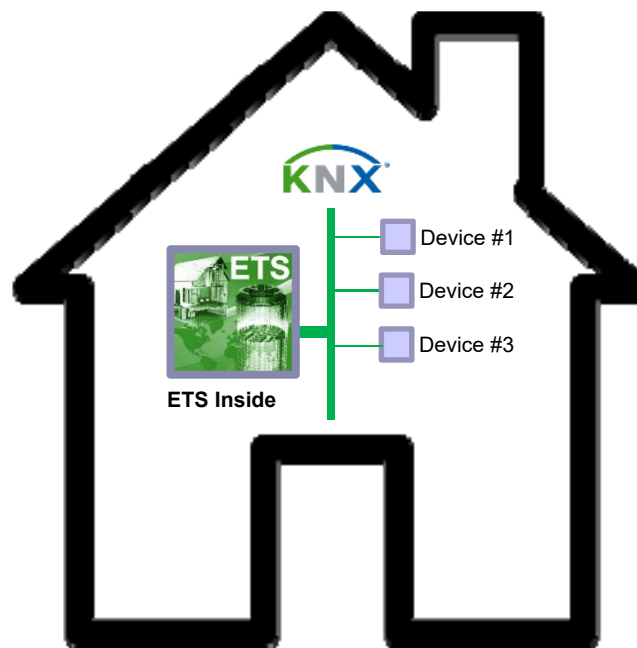

New perspectives with KNX

ETS Inside → User Interface



Project Dashboard

Project Functions

- Connection and project settings
- Diagnostics

Project Overview

- Imported and open projects
- View project details

New perspectives with KNX

ETS Inside → User Interface



Project Building Overview

Building Browser

- Easy overview of building (parts)

Device View

- Information on devices embedded in tiles

Device Name	Location	Device Name	Location	Device Name	Location
Push button interface FM	2.1.12 - Lys bad 141, vannstern, MK vindu, re... Sengerom 138	4 input flush mounted	2.1.9 - Akt lys i-lyd, spotlight stue, lys stue t... Sengerom 138	4 input flush mounted	2.1.10 - Spotlight entre, MK dar, reserve, res... Sengerom 138
4 input flushs mounted	2.1.11 - R mottaker, 1-smykke, 2-kvitering, 3... Sengerom 138	RAM 710 EIB	2.1.29 - Termstat bad Sengerom 138	Emergency Inverter	2.1.13 - Ledelys Spisestue 140
4 input flush mounted	2.1.25 - Binering, 4C	Emergency Inverter	2.1.83 - Ledelys Stue 142	Emergency Inverter	2.1.17 - Markeringlyse Stue 142
Emergency Inverter	2.1.21 - Ledelys Stue 142	4 input flush mounted	2.1.19 - Binering, 4C	4 input flush mounted	2.1.18 - Binering, 4C
4 input flush mounted	2.1.20 - R mottaker, 1-smykke, 2-kvitering, 3... Stue 142	gesis EIB V-0/4	2.1.15 - Wieland akt. Korridor 143	gesis EIB V-0/4	2.1.31 - Wieland akt. Korridor 143
gesis EIB V-0/4	2.1.34 - Wieland akt. Korridor 143	gesis EIB V-0/4	2.1.39 - Wieland akt. Korridor 143	gesis EIB V-0/4	2.2.31 - Wieland akt. Korridor 143
gesis EIB V-0/4	2.2.17 - Wieland akt. Korridor 143	gesis EIB V-0/4	2.2.5 - Wieland akt. Korridor 143	gesis EIB V-0/4	2.1.4 - Wieland akt. Korridor 143
gesis EIB V-0/4	2.2.11 - Wieland akt. Korridor 143	gesis EIB V-0/4	2.2.3 - Wieland akt. Korridor 143	gesis EIB V-0/4 B	2.1.1 - Wieland akt. Korridor 143

New perspectives with KNX

ETS Inside → Facts & Information



System

- User → iOS, Android, W10
- ETS Inside Device → W10 (IoT), more planned
- Size of installation when creating it with ETS inside: 255 devices – one project

Release

- 10/2016

Price

- 160 €/license (incl. dongle, without *ETS Inside* device)

More Information/ Live View

- see live demonstrations of ETS Inside here at L+B
 - KNX IoT city (that's here ...)
 - Hall 8, F98
 - Hall 9, B30

New perspectives with KNX



Timing

New perspectives with KNX

Release Dates

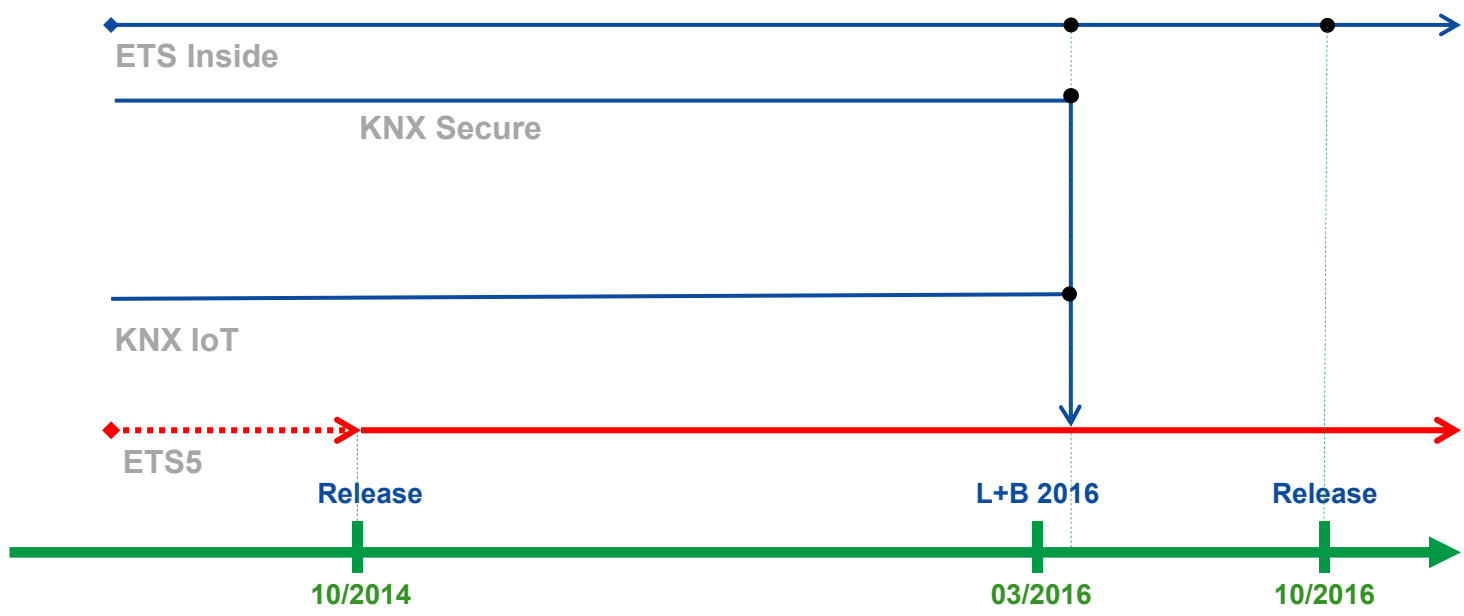

New perspectives with KNX



Thanks!